



for Automatic Sprinkler Systems
Stainless Steel Flexible Hose Fitting

واردات و فروش شلنگ رابط اسپرینکلر
مورد تائید سازمان آتش نشانی
دارای تائیدیه UL



www.sabatam.com

Feature

- **Safe & Reliable**

All the parts of MECH brand flexible hoses are manufactured in corrosion resistant and high-powered stainless steel with 100% leak tested prior to leaving the factory and the environmental temperature resistance being as high as 107°C/225°F.

- **Easy and Quick installation**

No special tools are required and It only needs the simple use of wrench, screw driver and pipe sealing tape, etc, in the installation with the minimal amount of time. The flexibility of MECH brand hose can be adjusted based on the installation space and can also be combined with 90° elbow, which allows hose to be fixed in limited installation space.

- **Economizing on cost**

With the unique connection mode of flexible hose, the MECH brand is much more time and cost saving and with no need of any machine against traditional hard pipe system installation.

- **Environmental Friendly**

The MECH brand flexible hose can be re-shaped and relocated to suit the final sprinkler location on the ceiling without draining the system, avoiding the pipe wasted by the inaccurate measurement. No sprinkler displacement even after high pressure test and eliminating the need for an oversized ring around the sprinkler.

- **Seismically**

The MECH brand stainless steel hose can absorb seismic shock, and protect the sprinkler system to maintain normal operation in the case of an earthquake.



10X
Faster

10 times time saving
against traditional installation

100
circles

The assurance of 100
bends without damage

100%
Tested

100% leak tested
prior to leaving the factory

Earth
quake

Reducing the damage
in the earthquake

7.0Mpa
Burst Test

The burst test pressure
being as high as 70 bar



Technical Specifications



Style: MDFU

Unbraided Hose with Straight Nipple

listing:  (limited flexibility)

Connection: DN25xDN15orDN20(1"x1/2"or3/4")

Hose Diameter: O.D.26.8mm/1 1/16"Flow:22.5mm^{7/8}"

Maximum service pressure: 14bar/200PSI

Maximum ambient temperature: 107°C/225 F

Flexible hose		cULus listing data			
Hose Length	Sprinkler Thread Size	Max. Allow. Sprinkler K-factor	Max. No. of 90° Bends	Min. Bending Radius	EQL of 33.7mm/1" SCH40 Pipe
mm in.	DN In.	Metric Imprf.	n x 90°	mm in.	meters feet
700 28	15 ½	115 8.0	1	100 3.9	5.5 18
	20 ¾	202 14.0			7.3 24
1000 40	15 ½	115 8.0	2	100 3.9	10.1 33
	20 ¾	202 14.0			12.5 41
1200 48	15 ½	115 8.0	2	100 3.9	13.1 43
	20 ¾	202 14.0			14.0 46
1500 60	15 ½	115 8.0	3	100 3.9	19.2 63
	20 ¾	202 14.0			19.5 64
1800 72	15 ½	115 8.0	4	100 3.9	23.8 78
	20 ¾	202 14.0			24.4 80



Technical Specifications

Style: MDFB

Braided Hose with Straight Nipple

listing:



Connection: DN25xDN15orDN20(1"x1/2"or3/4")

Hose Diameter: O.D.26.8mm/1¹/₁₆"Flow:21.0/1³/₁₆"

Maximum service pressure: 14bar/200PSI

Maximum ambient temperature: 107°C/225 F



Flexible hose		FM approval data				cULus listing data			
Hose Length	Sprinkler Thread Size	Max. Allow. Sprinkler K-factor	Max. No. of 90° Bends	Min. Bending Radius	EQL of 33.7mm/1" SCH40 Pipe	Max. Allow. Sprinkler K-factor	Max. No. of 90° Bends	Min. bending Radius	EQL of 33.7mm/1" SCH40 Pipe
mm in.	DN in.	Metric Imprl.	n x 90°	mm in.	meters feet	Metric Imprl.	n x 90°	mm in.	meters feet
700 28	15 ½	115 8.0	1	250 9.8	8.1 26.7	81 5.6	2	100 3.9	7.6 25.0
	20 ¾	202 14.0			6.5 21.5	115 8.0			6.4 21.0
	15 ½	115 8.0			12.9 42.6	81 5.6			10.1 33.0
1000 40	20 ¾	202 14.0	3	250 9.8	12.0 39.6	115 8.0	3	100 3.9	11.0 36.0
	15 ½	115 8.0			16.2 53.2	81 5.6			11.9 39.0
	20 ¾	202 14.0			15.7 51.6	115 8.0			13.1 43.0
1200 48	15 ½	115 8.0	3	250 9.8	20.6 67.8	81 5.6	3	100 3.9	15.2 50.0
	20 ¾	202 14.0			19.3 63.5	115 8.0			15.8 52.0
	15 ½	115 8.0			25.1 82.4	81 5.6			17.7 58.0
1500 60	20 ¾	202 14.0	4	250 9.8	22.9 75.4	115 8.0	3	100 3.9	19.2 63.0
	15 ½	115 8.0			25.1 82.4	81 5.6			17.7 58.0
	20 ¾	202 14.0			22.9 75.4	115 8.0			19.2 63.0



Structure & Material Specification

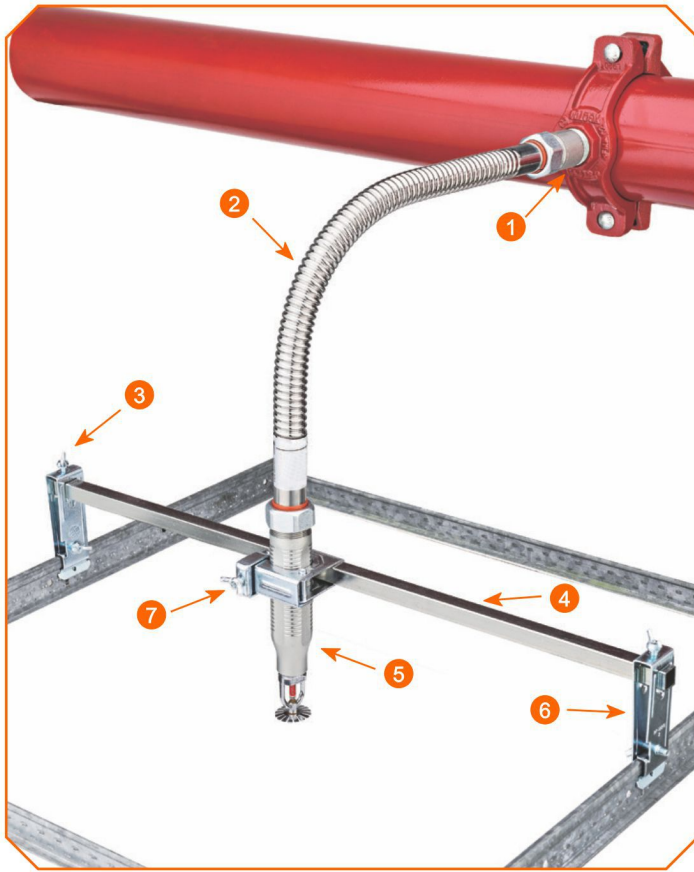

1 Inlet Nipple



2 ※ Braided hose
※ Unbraided hose



3 ※ Wing screw set



※ Hexagon screw set



4



5 ※ 90°bend



※ Straight



6 ※ Long side bracket



※ Shot side bracket



7 ※ Center bracket regular



※ Fast center bracket

Description		Material
Corrugated tube Braid&collar-rings		AISI 304 stainless steel
Discharge Nipple	Straight	Galv Steel ASTM 1020
	90° Bend	Galv Steel ASTM 1020
Inlet Nipple		Galv Steel ASTM 1020
Hexagon Slip nut		Galv Steel ASTM 1020
Gasket		EPDM
Isolation Ring		Nylon 66
Center Bracket	Fast Center Bracket	Galv. Steel ASTM A283 Gr.D
	Regular Center Bracket	Galv. Steel ASTM A283 Gr.D
Side Bracket	Long Side Bracket	Galv. Steel ASTM A283 Gr.D
	Short Side Bracket	Galv. Steel ASTM A283 Gr.D
Square Bar		Galv. Steel ASTM A283 Gr.B
Bolts & Screws	Hexagon Screw Set	Galv. Steel ASTM A283 Gr.D
	Wing Screw Set	Galv. Steel ASTM A283 Gr.D



How To Install

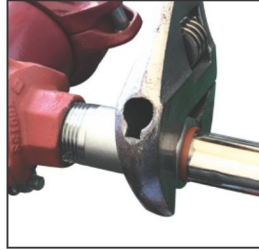

• INLET NIPPLE INSTALLATION

Using pipe wrench to connect Inlet Nipple and mechanical tee of the water supply pipeline, sealing with Teflon tape or pipe glue, etc. Tightening torque would be around 50 N•m(35ft-lbs). Checking the Hexagon nut to keep the mechanical tee and pipe line in good sealing performance.

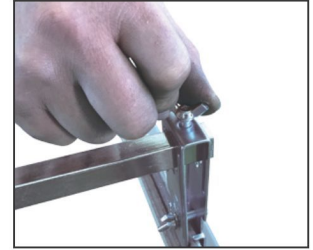
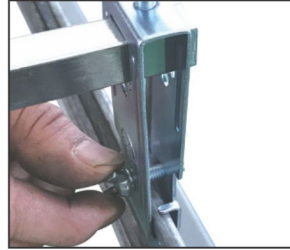

• BRACKET SYSTEM INSTALLATION

Connecting the square bar through three brackets. One bracket is in the middle of square bar is for Discharge Nipple. The other two brackets should be put two sides of the bar. After putting the side brackets into right location, fixing the side brackets to the main-rail and tightening all the bolts on brackets with torque 4 N•m (3ft-lbs)

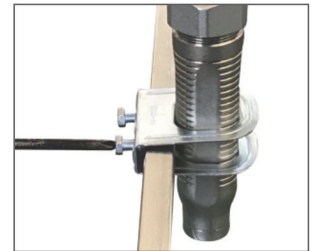
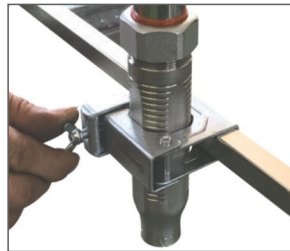
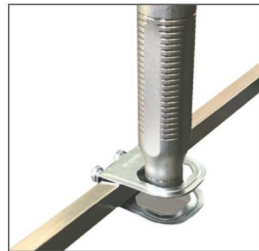

• HOSE BENDING ADJUSTMENT

Before connecting Discharge Nipple to the center bracket, all the hose bending must be adjusted to the right position according to the requirement of below hose bending degrees. Then tightening the center bracket with torque 4 N•m(3ft-lbs)

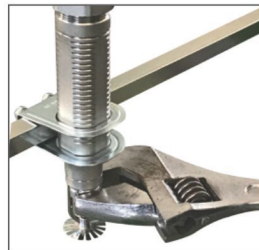
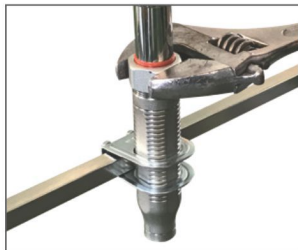

• DISCHARGE NIPPLE and SPRINKLER INSTALLATION

Tightening the nut of Discharge Nipple with torque 15 N•m(12ft-lbs).

Connecting the sprinkler head to Discharge Nipple according to the sprinkler installation instructions.

Taking the leakage test in according with NFPA guidelines.



Use Mech Radius Check Hose Bend

Use outer edge check MDFU unbraided hoses

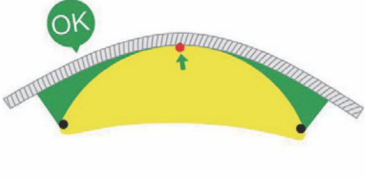
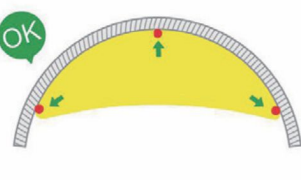
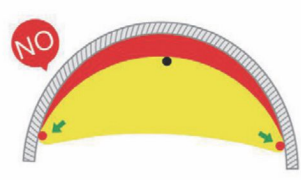
		
GREATER than ✓	EQUAL to ✓	SMALLER than ✗

Use inner edge check MDFB unbraided hoses

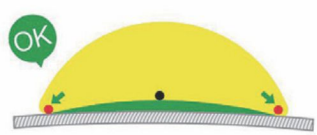
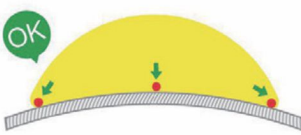
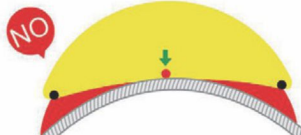
		
GREATER than ✓	EQUAL to ✓	SMALLER than ✗

HOSE BENDING, CORRECT OR WRONG

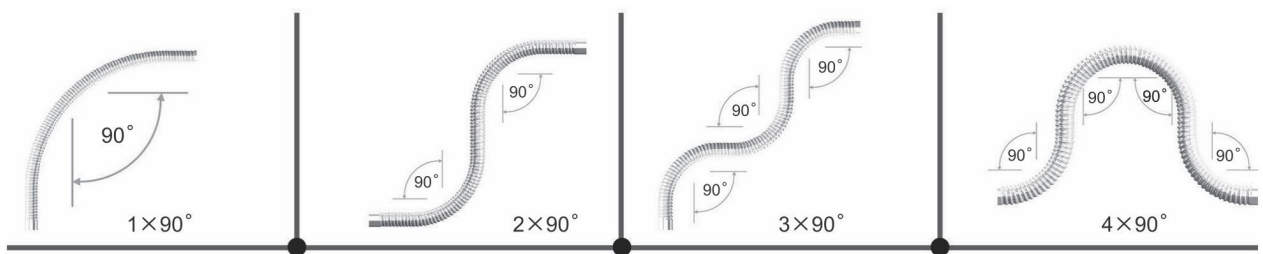

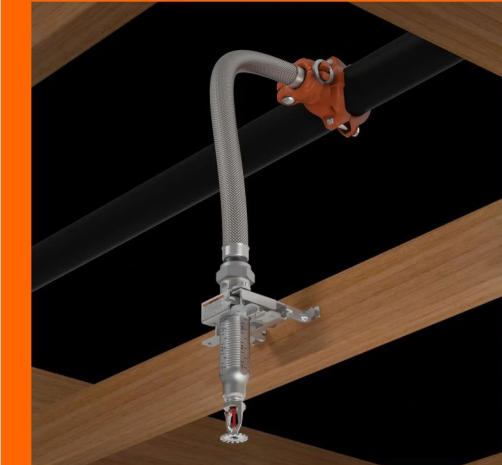
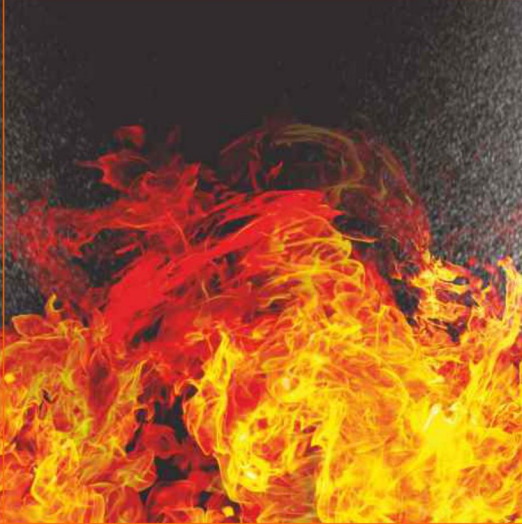
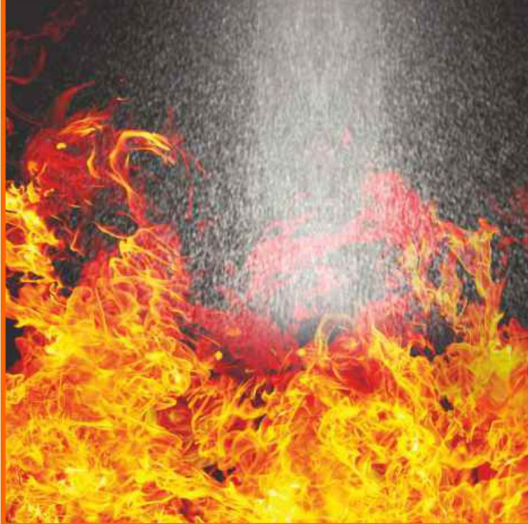
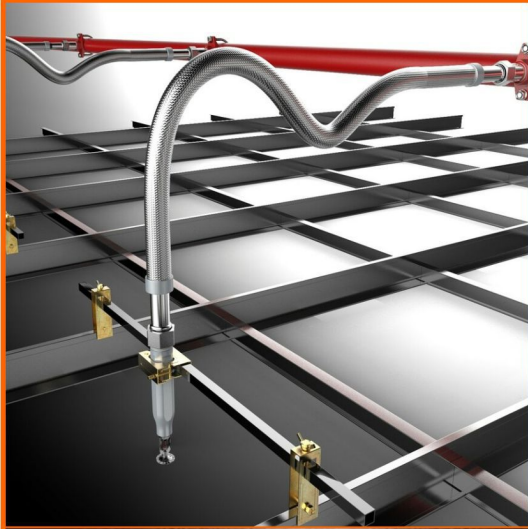

for Automatic Sprinkler Systems
Stainless Steel Flexible Hose Fitting